



**OptimaLED<sup>®</sup>**  
**ProTour<sup>®</sup>**

# LED BARCELONA Floodlights for Football Fields

*Best lighting solution for sports field.*

# Professional LED ---

The Professional LED Mast Lighting is gaining great acceptance in sports fields, as it positively influences the players' performance and contributes to proper refereeing. Additionally, the audience enjoys the match with higher quality and safety since the negative effects of glare are minimized.

Our optical system has been designed to ensure high power while minimizing glare.

## Characteristics ---

- Low Glare
- High power
- Asymmetric Optics

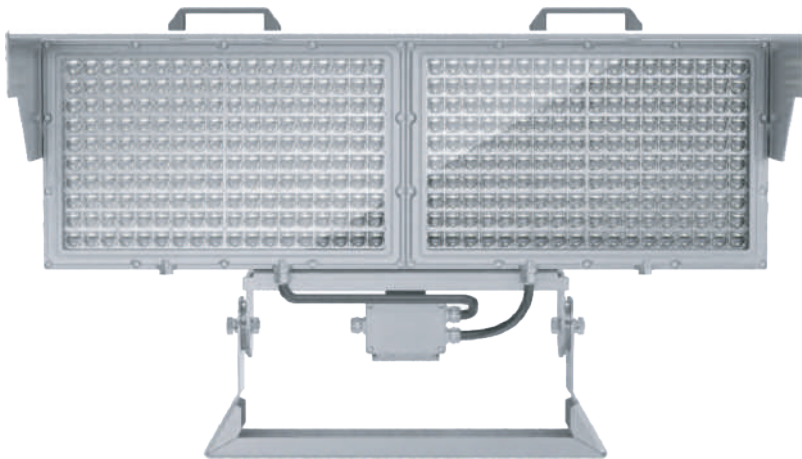

- Tempered Glass Lens
- Pure Aluminum Housing
- Pure Aluminum Housing

### Features



**OUTDOOR  
USE**



**LOW GLARE**

## Precise Rotation Angle\_\_\_\_\_

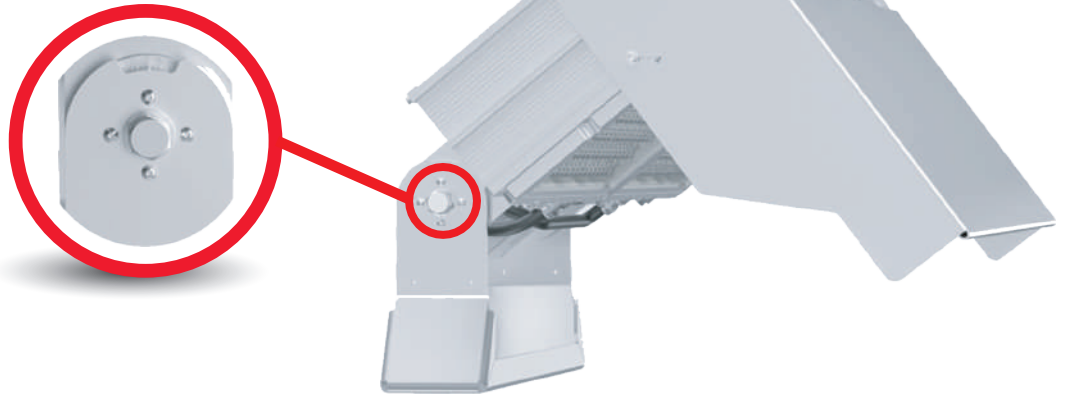

## Optional Position Laser\_\_\_\_\_

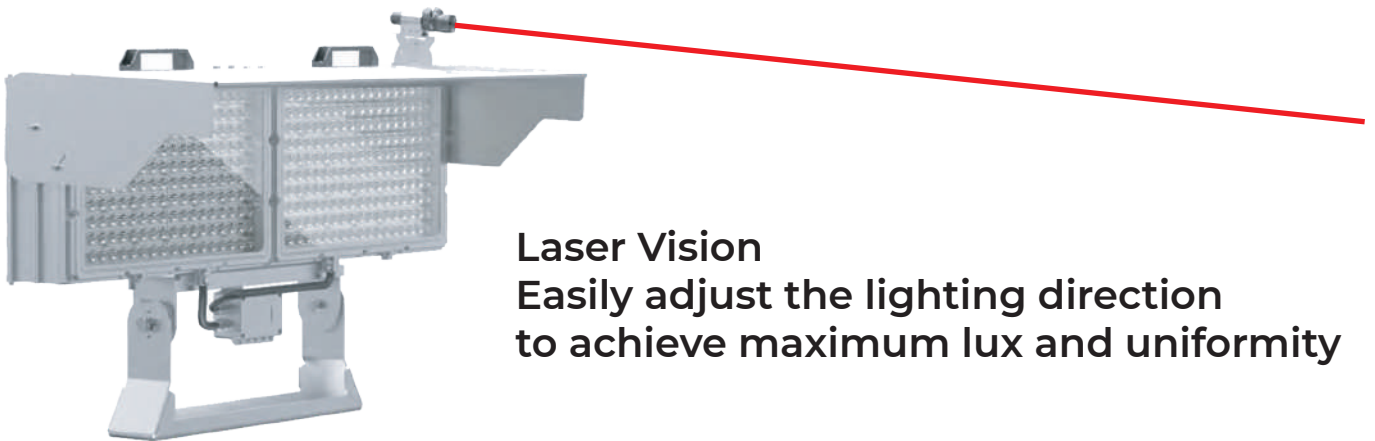

**Laser Vision**  
Easily adjust the lighting direction  
to achieve maximum lux and uniformity

## Rotating Visor\_\_\_\_\_

The asymmetric  
polarized optics and  
the visor work together  
to minimize glare, backlight,  
and scattered light.

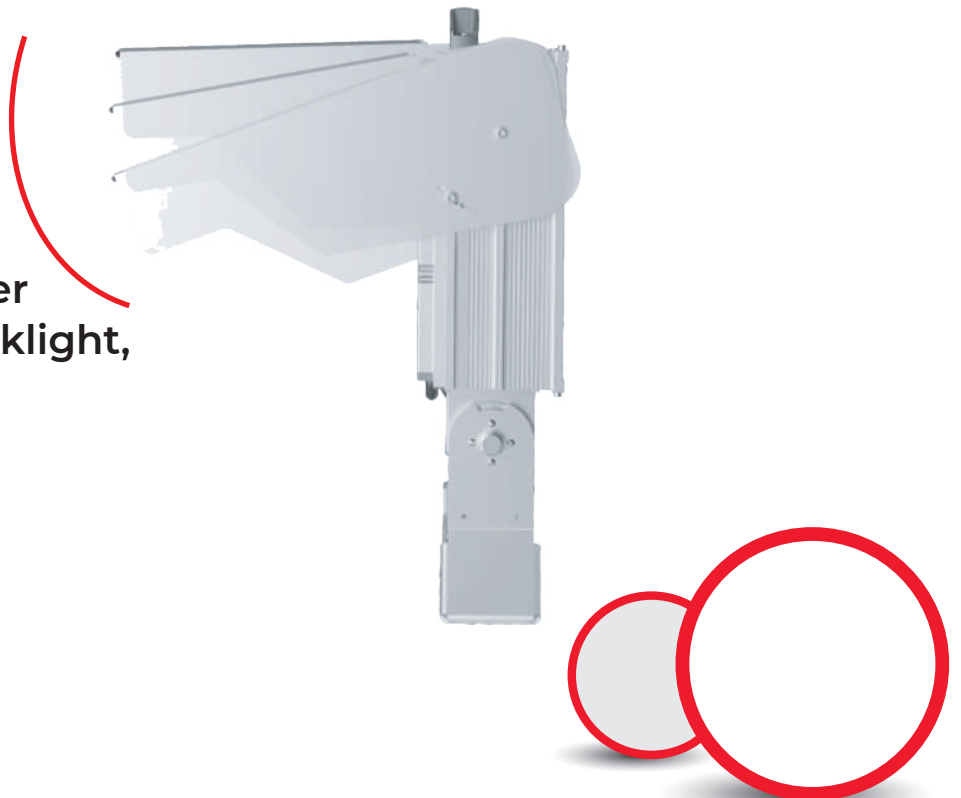

## Precise Rotation Angle

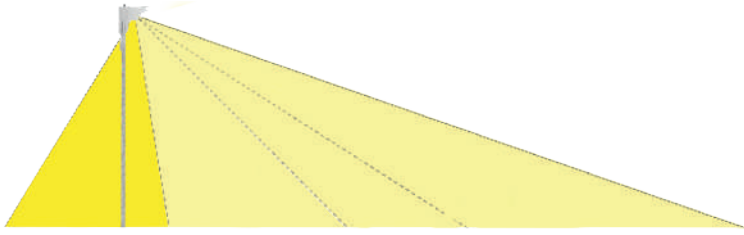

**Standard Spotlight**

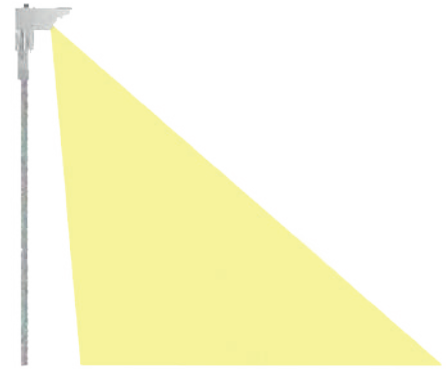

**Optimal LED Spotlight**

Without light loss on the rear and focused on the field, it enhances visibility, reduces glare, and minimizes light pollution.

## Other Characteristics



**IP66**

Water Protection

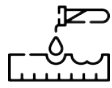

**AkzoNobel**

Corrosion Resistant



**TVS protection**

The TVS with peak capabilities of 1500W in a 10/1000us waveform is used to protect the LEDs from higher voltage, including lightning.

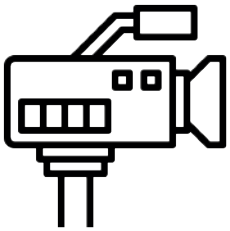

### **Excellent for TV broadcasting**

The LED source has a high TLCI (Television Lighting Consistency Index) and a color rendering index of up to 90. This provides the camera with the true color of the scene and flicker-free shots.

## Boc Driver

The controller box can be fixed on the bracket or on the pole to reduce the weight of the entire accessory and facilitate maintenance.

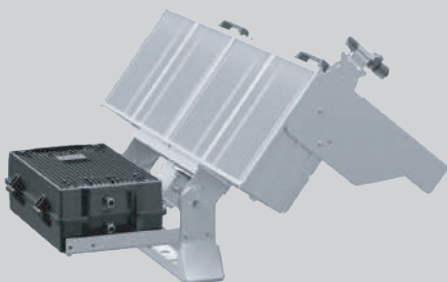

# Características Técnicas

- > **Carcasa:** Pure Aluminum
- > **Conductividad:** 226 W/m·K
- > **LED:** Cree 5050
- > **CRI:** Ra>70
- > **SDCM:** <6
- > **Factor de potencia:** >0,95
- > **THD:** <15
- > **Conductor:** Inventronic
- > **Eficiencia del conductor:** >93 %
- > **Protección:** OTP, OCP, OVP, SCP
- > **Protección contra sobretensiones:** 10KV
- > **Impermeable:** IP66
- > **Prueba de impacto:** IK08
- > **Eléctrico:** 100-277V, 50/60Hz
- > **Temperatura de funcionamiento:** -40~50 °C
- > **TM21:** L90B10>50,000H
- > **Vida útil:** 50,000H

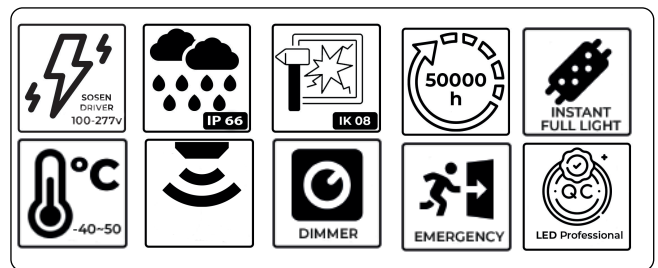

| Modelo      | W     | V        | Lumenes  | CRI | IP   | Dimensiones |
|-------------|-------|----------|----------|-----|------|-------------|
| FLCF-500-OL | 500W  | 100~277V | 80000LM  | >70 | IP66 | 470*524*127 |
| FLCF-600-OL | 600W  | 100~277V | 96000LM  | >70 | IP66 | 470*524*127 |
| FLCF-1K0-OL | 1000W | 220~240V | 160000LM | >70 | IP66 | 920*558*127 |
| FLCF-1K2-OL | 1200W | 220~240V | 192000LM | >70 | IP66 | 920*558*127 |

## OPCIONES DE ÓPTICA

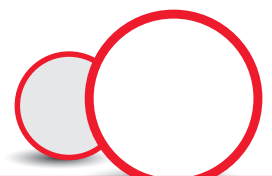
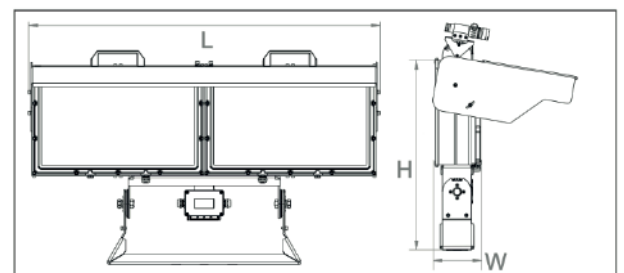
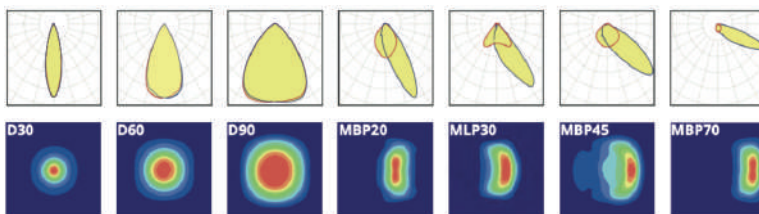

# *Optima*LED<sup>®</sup> ProTour<sup>®</sup>

## LIGHTING EVOLUTION

---

### FORGING THE PATH TO A BRIGHT FUTURE

In an increasingly energy-efficient and sustainable-conscious world, quality is THE fundamental aspect for our company. We are committed to providing products that meet the highest standards of performance, durability, and safety. We conduct rigorous testing on our products and use quality components to ensure reliable long-term operation.

We invest in R&D to stay at the forefront of LED technology, continuously researching and developing new solutions to enhance the efficiency, durability, and versatility of our products. We stay abreast of the latest trends and advancements in the industry, enabling us to offer innovative solutions and stay ahead of the competition.

Experience, knowledge, and a commitment to quality and sustainability make us market leaders. We drive the shift towards



**WWW.OPTIMALED.EU**

---

**C/ Geológicas, 62  
28923 Madrid - Spain**

**PHONE  
+34 916357859**

---